

Waterman's *Ideal* Fountain Pens

•
A Catalogue of
FOUNTAIN PENS, PENCILS
DESK SETS & WRITING INKS
by
W. Waterman Co.



Waterman's Ideal Fountain Pens

THE DeLUXE INK-VUE (Available with nib actions described on center spread)

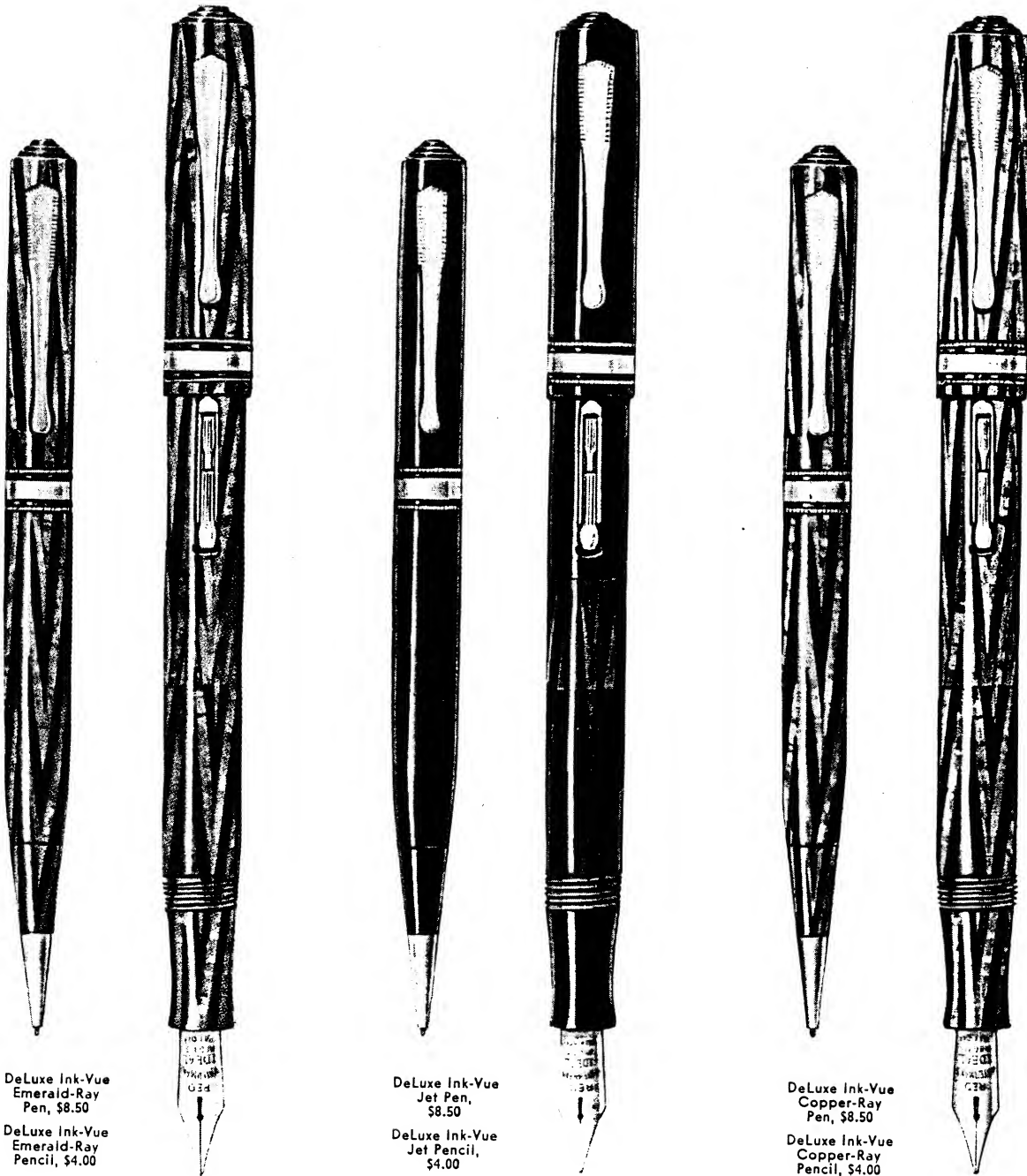

DeLuxe Ink-Vue
Emerald-Ray
Pen, \$8.50

DeLuxe Ink-Vue
Emerald-Ray
Pencil, \$4.00

DeLuxe Ink-Vue
Jet Pen,
\$8.50

DeLuxe Ink-Vue
Jet Pencil,
\$4.00

DeLuxe Ink-Vue
Copper-Ray
Pen, \$8.50

DeLuxe Ink-Vue
Copper-Ray
Pencil, \$4.00

The DeLuxe INK-VUE is the largest and finest of Waterman's new visible ink pens. As in all pens of this type the ink supply is visible at all times and thus tells you when to refill. Trouble-making springs, pistons and packing usually found in a visible ink pen are absent in an INK-VUE pen! The patented "Double Action Lever" assures simple and positive filling—and locks down without ejecting ink. This feature and the simplified design—allowing a bigger reservoir—permit INK-VUE pens, size for size, to carry more ink than any other visible ink pen.

Waterman's Ideal Fountain Pens

THE STANDARD INK-VUE
 (Available with nib actions described on center spread)



No. 84-E Emerald-Ray
 Ink-Vue Pen (with gold-
 filled mountings), \$6.00
 No. 85-E Emerald-Ray
 Ink-Vue Pencil (gold-
 filled mountings) \$3.00

No. 84-C Copper-Ray
 Ink-Vue Pen, \$6.00
 No. 85-C Copper-Ray
 Ink-Vue Pencil, \$3.00

No. 84-S Silver Ray
 Ink-Vue Pen, \$5.00
 No. 85-S Silver Ray
 Ink-Vue Pencil, \$3.00

No. 84-J Jet
 Ink-Vue
 Pen, \$5.00
 No. 85-J Jet
 Ink-Vue
 Pencil, \$3.00

No. 84-R Emerald-Ray
 Ink-Vue Pen (with
 chrome mountings), \$5.00
 No. 85-R Emerald-Ray
 Ink-Vue Pencil to match
 above pen, \$3.00

Waterman's Ideal Fountain Pens

THE LADY PATRICIA

(Available with nib actions described on center spread)

INK-VUE

REGULAR TYPE



Lady Patricia
Ink-Vue, Black Lace,
Pen, \$5.00

Lady Patricia
Ink-Vue, Sunset,
Pen, \$5.00

Lady Patricia
Ink-Vue, Mist,
Pen, \$5.00

Lady Patricia
Ink-Vue, Black Lace,
Pencil, \$3.00

Lady Patricia
Ink-Vue, Sunset,
Pencil, \$3.00

Lady Patricia
Ink-Vue, Mist,
Pencil, \$3.00

Lady Patricia
Onyx
Pen, \$5.00

Lady Patricia
Onyx
Pencil, \$3.00

Lady Patricia
Persian
Pen, \$5.00

Lady Patricia
Persian
Pencil, \$3.00

Lady Patricia
Jet
Pen, \$5.00

Lady Patricia
Jet
Pencil, \$3.00

Lady Patricia
Moss-Agate
Pen, \$5.00

Lady Patricia
Moss-Agate
Pencil, \$3.00

The Lady Patricia is designed from cap to tip for the modern woman. It is not only a perfect writing instrument but it is attractive enough to be used as a prized accessory in her handbag. Dainty, jewel-like design. Slender grip. The smart clasp secures Lady Patricia upright in any handbag. Polished disc on top of cap for engraving.

The Lady Patricia Ink-Vue has all the beauty of design of the Regular Type of Lady Patricia and, in addition, embodies Waterman's patented Ink-Vue features—that tell when to refill pen. Easy to fill. Larger ink supply.

A Waterman's Point for Every WATERMAN'S POINT



PURPLE—Stiff-fine
Writes a fine, uniform line. Ideal for Gregg shorthand. Firm enough for carbon copies. Writes even finer on back.

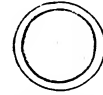

PINK—Flex-fine
An unusually smooth flexible-fine point. It will shade at any angle. For Pitman shorthand and other systems requiring shading.



BROWN—Fine
A finely tapered point for general use. Writes smoothly with moderate flexibility. Good for bookkeeping and beginners at writing.



RED—
Asplend: ence an point of bility. dium wic the aver.

Points described above are available for any Waterman's Pen. They are shaped, tempered and ground to deliver a line of being different and identified by a color for easy selection, such as Fine Accountant, stiff and needle fine—A

Thus, one may secure a point to suit any handwriting, Stenography, Manifolding, Music Writing, Sk

WHY WATERMAN'S PEN

Waterman's Pens are made of the very finest of materials. Each Waterman's Pen embodies every modern feature that could possibly be made, 14-kt. gold iridium tipped point—and its quick-starter—writing instantly upon touching the p

All Waterman's—Regular Type and INK-VUE—are made of unbreakable material and are perfectly balanced for use. The name "Waterman's" on a fountain pen is



No. 7-J Jet Pen, \$7.00



No. 97-J Jet Pencil, \$3.00



No. 7-E Emerald-Ray Pencil, \$3.00



Waterman's Junior Jet Pen, \$2.50



Waterman's Junior Jet Pencil, \$1.00

No. 7-E Emerald-Ray Pen, \$7.00

NOTE: The Junior Pen comes only with Fine, Medium, Coarse or Stub points.



Handwriting or Writing Vocation ELECTION CHART



GREEN—Rigid
A durable stiff point of medium width that will not shade even under pressure. Best for carbon copy work. Smooth, gliding point.



YELLOW—Rounded
Writes a bold line—a fine line on back. For bold signatures and left-handed writers. Writes smoothly on any paper in any direction.



BLUE—Blunt
An improved stub, slightly oblique. Makes thick or thin strokes. Liked by writers who hold pen between first and second fingers.

In this catalogue except Waterman's Junior. Main point action—each of the seven points. In addition, we make various special points—Music Point—Oblique Stub, etc. For writing vocation—as Bookkeeping, Account-ants, etc.

THE PERFECT WRITERS

and with a skill born of over a half-century of beautifully styled—from tip to cap—but for its writing service. Because of its perfectly correct ink-feed—each Waterman's is a match without skipping or flooding.

an ample ink capacity. Holders are made of durable, non-tiring writing.

guarantee of years of perfect writing service!

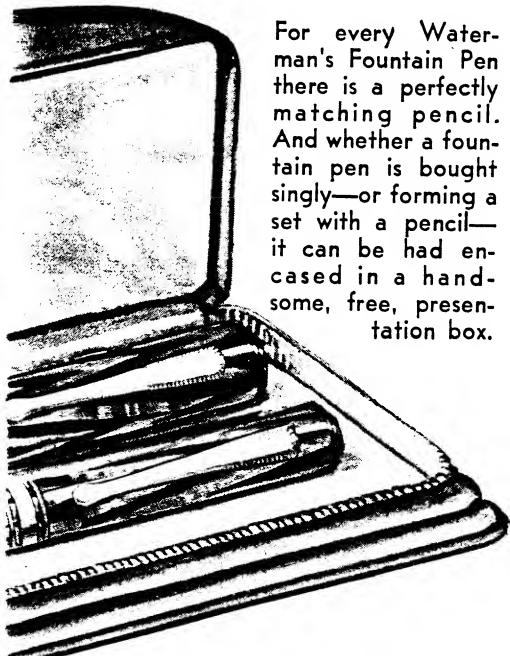

For every Waterman's Fountain Pen there is a perfectly matching pencil. And whether a fountain pen is bought singly—or forming a set with a pencil—it can be had encased in a handsome, free, presentation box.

DeLuxe Ink-Vue Writing Set in Emerald-Ray, \$12.50



No. 95-J Jet Pencil, \$3.00



No. 5-J Jet Pen, \$5.00

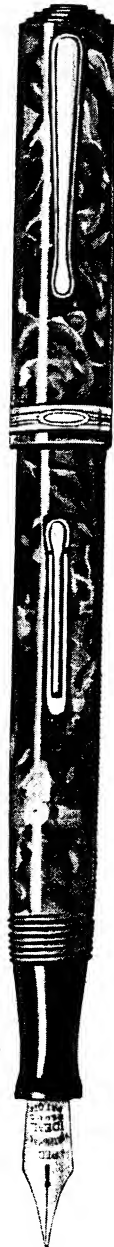

No. 94-G Grey Pen, \$5.00

No. 95-G Grey Pencil, \$3.00



No. 94-M Moss-Agate Pen, \$6.00

No. 95-M Moss-Agate Pencil, \$3.00



No. 94-J Jet Pen, \$6.00

No. 0795-J Jet Pencil, \$3.00

Waterman's Ideal Fountain Pens

PENS—\$3.50

PENCILS—\$1.50

REGULAR TYPE OF PEN
GOLD-FILLED MOUNTED

Pens on this page may be had with any of the points described on center spread—but for the Purple, Yellow or Green point there will be an extra charge of 50c.

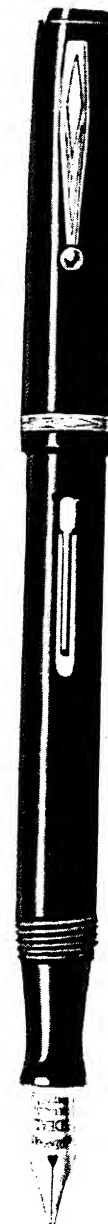
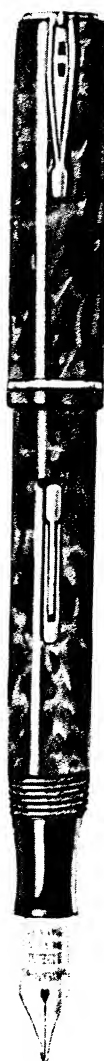
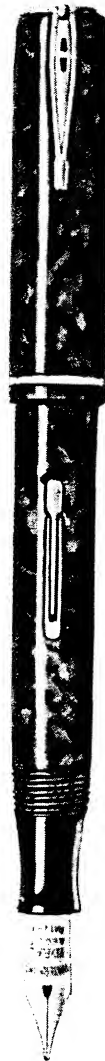

No. 92-S
Steel Quartz
Pen, \$3.50

No. 92-G
Green Pearl
Pen, \$3.50

No. 92V-B
Black Pearl
Pen, \$3.50

No. 92V-C
Claret
Pen, \$3.50

No. 92V-G
Green Pearl
Pen, \$3.50

No. 92V-J
Jet Pen,
\$3.50

No. 92V-S
Steel Quartz
Pen, \$3.50

No. 92-B
Black Pearl
Pen, \$3.50

No. 92-J
Jet Pen,
\$3.50

No. 91-S
Steel Quartz
Pencil, \$1.50

No. 91-G
Green Pearl
Pencil, \$1.50

No. 91V-B
Black Pearl
Pencil, \$1.50

No. 91V-C
Claret
Pencil, \$1.50

No. 91V-G
Green Pearl
Pencil, \$1.50

No. 91V-J
Jet Pencil,
\$1.50

No. 91V-S
Steel Quartz
Pencil, \$1.50

No. 91-B
Black Pearl
Pencil, \$1.50

No. 91-J
Jet Pencil,
\$1.50

The Nos. 92 and 92V pens—and the Nos. 3 and 3V pens on opposite page—represent the most outstanding values in fountain pens at their prices. They are perfect writing instruments in every particular. Pens are of Waterman's famous lever-filling type—a simple, efficient method of filling that has proven popular. They are especially suitable for boys and girls at school—and for the many adults who prefer a moderately priced pen in these sizes.

Waterman's Ideal Fountain Pens

PENS — \$3.00

PENCILS — \$1.25

REGULAR TYPE OF PEN
CHROME MOUNTED

Pens on this page may be had with any of the points described on center spread—but for the Purple, Yellow or Green point there will be an extra charge of 50c.



No. 3-J
Jet Pen,
\$3.00

No. 93-J
Jet Pencil,
\$1.25



No. 93-B
Black Pearl
Pencil, \$1.25

No. 3-B
Black Pearl
Pen, \$3.00



No. 3V-G
Green Pearl
Pen, \$3.00

No. 93V-G
Green Pearl
Pencil, \$1.25



No. 3V-S
Steel Quartz
Pen, \$3.00

No. 93V-S
Steel Quartz
Pencil, \$1.25

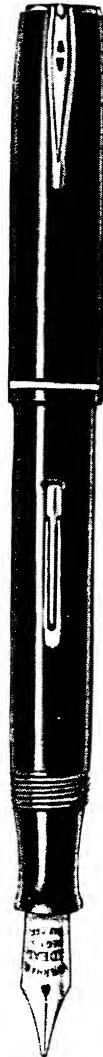

No. 3V-J
Jet Pen,
\$3.00

No. 93V-J
Jet Pencil,
\$1.25



No. 3V-C
Claret
Pen, \$3.00

No. 93V-C
Claret
Pencil, \$1.25



No. 3V-B
Black Pearl
Pen, \$3.00

No. 93V-B
Black Pearl
Pencil, \$1.25



No. 3-S
Steel Quartz
Pen, \$3.00

No. 93-S
Steel Quartz
Pencil, \$1.25



No. 3-G
Green Pearl
Pen, \$3.00

No. 93-G
Green Pearl
Pencil, \$1.25

Waterman's Ideal Inks



Well Top, 15c a bottle, these colors: No. 182 Blue Black; No. 282 Green; No. 382 Violet; No. 582 Red; No. 682 Blue, and No. 782 Jet Black.



Waterman's Ideal Inks are absolutely the best for your fountain pen and for general use. They are skilfully made from the very finest of raw materials—and are uniform in colors and free from clogging sediment.

Waterman's Blue Black and Jet Black Inks are permanent, non-fading record inks. Unequaled for use on bank checks, office records or wherever it is essential that the writing be preserved in a permanently legible state.

Waterman's Blue Ink writes a bright blue. Because it is so easily washed from hands or fabrics with ordinary soap and water it is the ideal ink for school use.

Waterman's Green, Violet and Red Inks are made in beautiful colors for many useful purposes in offices, schools and home.

THE WELL TOP BOTTLE

You'll be intrigued by the convenience of this most unique fountain pen bottle! No matter how little ink remains in the bottle, it can be instantly transferred to the "well" at the top. And unlike other containers of this character, the "well" occupies the entire inside of the bottle's extra wide and deep neck.

Just turn the bottle upside down. Ink completely fills neck. Then flip bottle back to its base. Ink has remained in well—within easy reach of a fountain pen. A secure but easy-to-open screw cap seals the container.

CORRESPONDENCE INKS

In six beautiful and unusual colors to match or harmonize with tinted personal correspondence papers — Aztec Brown, Tropic Green, South Sea Blue, Patrician Purple, Spanish Tile and Jet Black. Daintily bottled — 15c each.

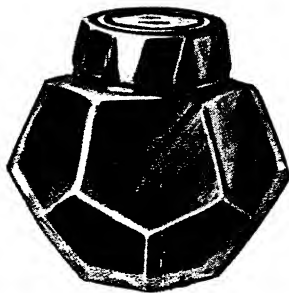

DE LUXE TIP-FILL

The sharp, iridescent facets of this 4 oz. container of Waterman's Blue Black Ink make it attractive enough for any office desk or home secretary. Tipped on side, it allows a pen to get all of the ink. Wide neck. Molded screw cap. Generous 4 oz. — 25c

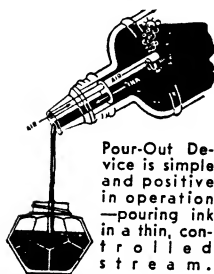

Pour-Out Device is simple and positive in operation — pouring ink in a thin, controlled stream.



Tip-Fill Bottle, 2 oz., 10c each; No. 172 Blue Black; No. 272 Green; No. 372 Violet; No. 572 Red; No. 672 Blue, and No. 772 Jet Black.

TIP-FILL BOTTLE

Above is shown Waterman's standard 2 oz. bottle—a good-looking and very convenient ink container. Its Tip-Fill feature is especially appreciated. When ink gets low, bottle may be tipped to new base (as shown above)—thus deepening the ink and allowing a fountain pen or dip pen to get the last drop. Extra wide neck. Sealed with secure screw cap.

COMMERCIAL SIZES WITH POUR-OUT

Business Offices, Schools and other large users of ink will find it decidedly economical to buy their Waterman's Ink in large containers equipped with our convenient, patented Pour-Out Device which allows small individual bottles to be quickly and cleanly filled as desired.

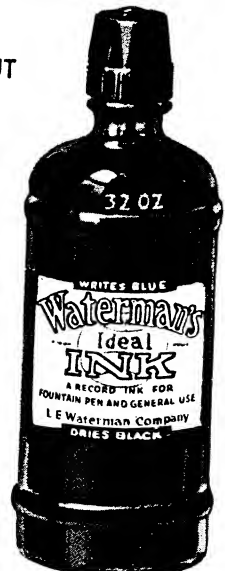

Blue Black, Jet Black, Blue, Green, Violet & Red Inks bear the same price, in these sizes:
 One Gallon, with Pour-Out Device\$4.00
 Half Gallon, with Pour-Out Device 2.25
 One Quart, with Pour-Out Device 1.25
 One Pint, with Pour-Out Device75
 Half Pint, without Pour-Out Device45

W. L. Waterman Company

191 BROADWAY, NEW YORK

40 School St. BOSTON 129 So. State St. CHICAGO 609 Market St. SAN FRANCISCO 263 St. James St. MONTREAL 41 Kingsway LONDON, W. C. 2 6 rue Monsigny PARIS

Waterman's Desk Sets

for Modern Offices and Homes
and for Trophies and Prizes.

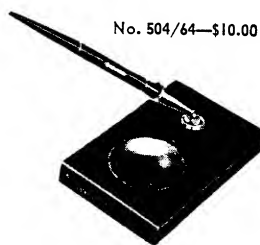

No. 511/62½—\$6.00



No. 418/67—\$22.00

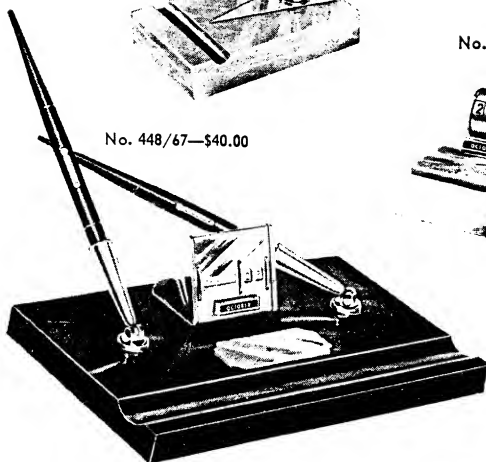
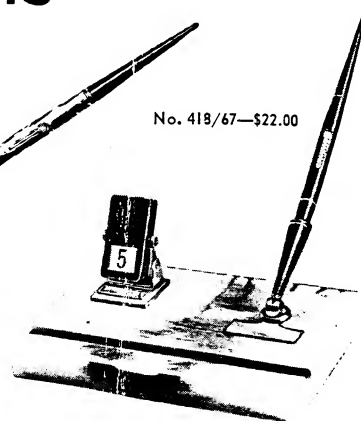

No. 439/67
\$25.00

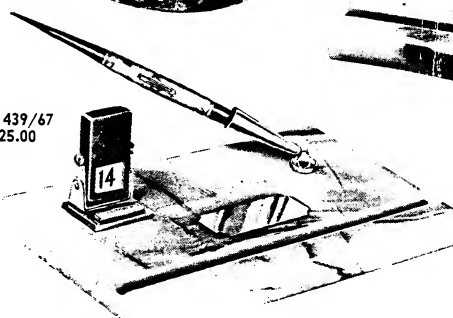

No. 433/67—\$50.00

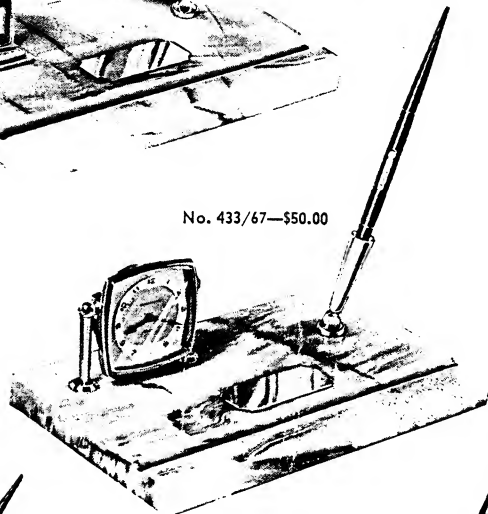

No. 525/67
\$25.00

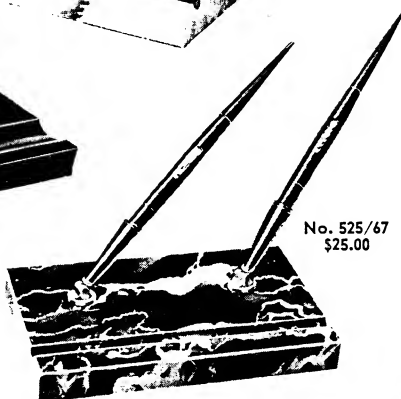

No. 303/67—\$40.00

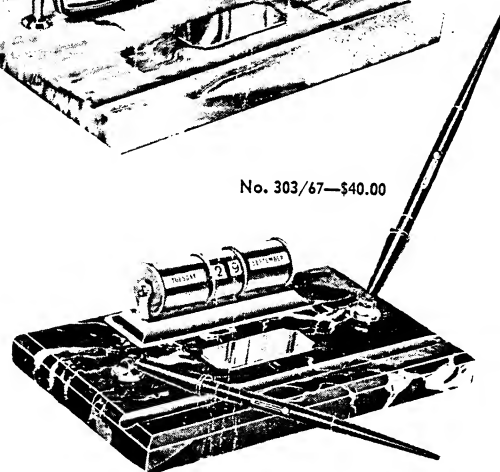

No. 510/62
\$10.00



No. 438/67
\$75.00

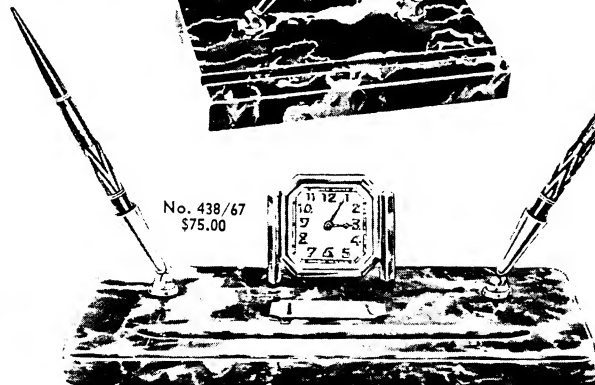

No. 503/62 — 3x4½ White Onyx, African Brown Onyx or Black and Gold Marble base, gold-filled name plate and sheath—or Belgian Black Marble base, chrome name plate and sheath—pen to match base—\$10.00.

No. 502/62—3x4½ White Onyx base, chrome or gold-filled decorative name plate and pen sheath, chrome or gold-filled trimmed Onyx pen—\$10.00.

No. 504/64—An appropriate set for equipping desks of office personnel. 4x6 Black Catalin base. Jet pen, chrome trimmed—\$10.00.

No. 511/62½—3x4 African Brown Onyx base, gold-filled sheath, Brown pen—\$6.00.

No. 418/67—Jet Turn-Over Perpetual Calendar, 5x8 White Onyx or Black and Gold Marble base. Chrome trim and name plate. Jet pen and

sheath—\$22.00. With Belgian Black Marble or Green Onyx base, pen to match—\$25.00.

No. 448/67—Chrome Triangle Model Calendar, on 6x10, Belgian Black Marble base, chrome sheaths and name plate, Jet pens—\$40.00.

No. 444/62—Chrome Cylinder Type Perpetual Calendar on 4x6 White Onyx base. Jet pen and sheath—\$15.00.

No. 439/67—Russet Metal Turn-Over Perpetual Calendar, gold-filled trim, sheath and name plate, 6x10 White Onyx base, Onyx pen—or Black and Chrome Calendar on Black and Gold Marble base—or all Chrome Calendar on Belgian Black Marble base—pen to match—\$25.00.

No. 525/67—5x8 Black and Gold Marble, Belgian Black Marble, White Onyx or African Brown Onyx base. Pens and sheaths to match—\$25.00.

No. 433/67—8-Day Waltham Clock, name plate and sheath in chrome, 6x10 White Onyx base. Jet pen (illustrated)—\$50.00. Same set in gold-filled, Green Onyx base, pen to match—\$55.00.

No. 510/62—A handsome modern set of Black Aragonite on 2½x4½ chrome metal base. Chrome sheath. Jet pen—\$10.00.

No. 438/67—Elgin 8-Day Clock, gold-filled finish, sheaths and name plate, on 7x13 Green Onyx base, two pens to match—\$75.00.

No. 303/67—Gold-Filled Cylinder Type Perpetual Calendar and name plate, Jet pens and sheaths, 6x10 Black and Gold Marble base (illustrated)—\$40.00. Same Calendar, gold-filled name plate and sheaths, Green Onyx base, pens to match base—\$45.00. Chrome Calendar and name plate, Belgian Black Marble base, Jet pens and sheaths—\$45.00.

We solicit your inquiries for desk sets designed to your order for special presentation.



Waterman's Ideal Fountain Pens



DeLuxe Ink-Vue Writing
Set in Emerald-Ray, \$12.50

INK-VUE

The Perfected Visible Ink Pen
That Tells When to Refill



(For every pen shown there is a perfectly matching pencil—the set being sold in a handsome gift case.)



DeLuxe Ink-Vue
Emerald-Ray, \$8.50
Pencil, \$4.00

DeLuxe Ink-Vue
Pencil,
Emerald-Ray, \$4.00

DeLuxe Ink-Vue
Jet, \$8.50
Pencil, \$4.00

Also in DeLuxe Ink-Vue Copper-Ray. Pen \$8.50. Pencil \$4.00.

The DeLuxe is the very finest of Waterman's Ink-Vues. The patented "Double Action Lever" makes Ink-Vue the simplest of all visible ink pens to fill—and the easiest to empty for cleaning. Ink-Vue Pens also have the biggest ink capacity.

Any of These Pens May Be Had w



PURPLE—Stiff-fine
Writes a fine, uniform line. Ideal for Gregg shorthand. Firm enough for carbon copies. Writes even finer on back.



PINK—Flex-fine
An unusually smooth flexible-fine point. It will shade at any angle. For Pitman shorthand and other systems requiring shading.



BROWN—Fine
A finely tapered point for general use. Writes smoothly with moderate flexibility. Good for bookkeeping and beginners at writing.



RED—
A splendor of point of ability. A dium wi the aver.



No. 84-C Copper-Ray
Ink-Vue, \$6.00
No. 85-C Copper-Ray
Pencil, \$3.00



No. 84-S Silver-Ray
Ink-Vue, \$5.00
No. 85-S Silver-Ray
Pencil, \$3.00



Lady Patricia
Ink-Vue, Sunset,
Pen, \$5.00
Pencil, \$3.00



Lady Patricia
Ink-Vue, Mist,
Pen, \$5.00
Pencil, \$3.00

In addition to the points described name), various special points are stiff and needle fine—Artists' Point

Waterman's

Also made in
No. 84-E Emerald-Ray Pen, \$6.00
No. 85-E Emerald-Ray Pencil, \$3.00
No. 84-J Jet Pen, \$5.00
No. 85-J Jet Pencil, \$3.00

Also made in
Lady Patricia Ink-Vue, Black Lace
Pen, \$5.00
Pencil, \$3.00

One of the Points Described Below



GREEN—Rigid
A durable stiff point of medium width that will not shade even under pressure. Best for carbon copy work. Smooth, gliding point.

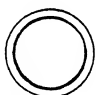

YELLOW—Rounded
Writes a bold line—a fine line on back. For bold signatures and left-handed writers. Writes smoothly on any paper in any direction.



BLUE—Blunt
An improved stub, slightly oblique. Makes thick or thin strokes. Liked by writers who hold pen between first and second fingers.

REGULAR SELF-FILLING TYPE With Waterman's Exclusive Self-Starting and Tip-Filling

(each identified by a color
like such as Fine Accountant,
c Point—Oblique Stub, etc.)

dy Patricia



dy Patricia
onyx, \$5.00
encil, \$3.00



Lady Patricia
Persian, \$5.00
Pencil, \$3.00

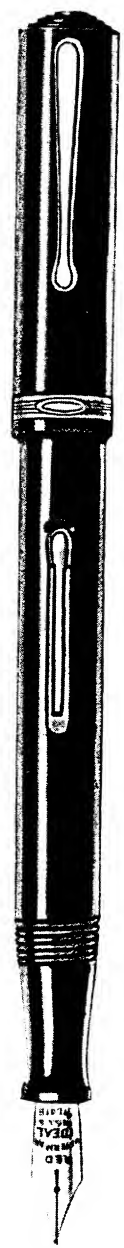

No. 94-J Jet
Pen, \$6.00
No. 0795-J Jet
Pencil, \$3.00



No. 94-G Grey
Pen, \$5.00
No. 95-G Grey
Pencil, \$3.00

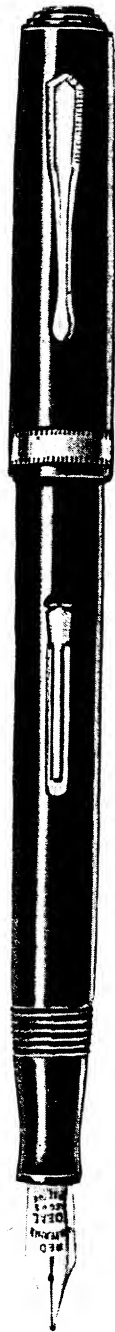

No. 7-J Jet
Pen, \$7.00
No. 97-J Jet
Pencil, \$3.00



The Patricia
Moss-Agate
Pen, \$10.00
Pencil, \$5.00



The Patricia
Turquoise
Pen, \$10.00
Pencil, \$5.00

Also made in Patricia Moss-Agate and Lady Patricia Pen, \$5.00. Pencils, \$3.00

Also made in No. 94-M Moss-Agate Pen \$6.00 No. 95-M Moss-Agate Pencil \$3.00 No. 5-J Jet (like No. 94-J except chrome mountings) Pen, \$5. No. 95-J Jet Pencil \$3

Also made in No. 7-E Emerald-Ray Pen, \$7.00, and No. 97-E Emerald-Ray Pencil, \$3.00

Also made in Patricia Onyx Pen, \$10.00 Matching Pencil, \$5.00 Patricia Jet Pen, \$10.00 Matching Pencil, \$5.00





Excellent Waterman's Pens at Moderate Prices

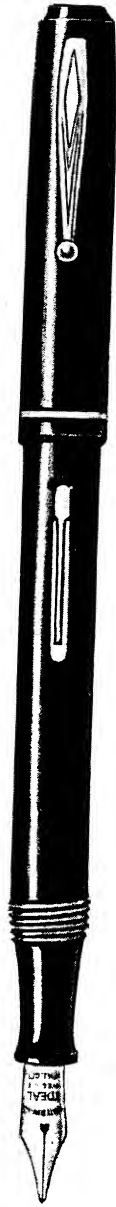

No. 92-J Jet Pen, \$3.50
No. 91-J Jet Pencil, \$1.50



No. 92-G Green Pearl Pen, \$3.50
No. 91-G Green Pencil, \$1.50



No. 92V-S Steel Quartz Pen, \$3.50
No. 91V-S Steel Quartz Pencil, \$1.50

Pens also in 92V-J Jet, 92V-G Green P., 92V-B Black P., 92V-C Claret

and Pencils in 91V-J Jet, 91V-G Green P., 91V-B Black P., 91V-C Claret

Pens, \$3.50
Pencils, \$1.50



Waterman's Junior Jet Pen, \$2.50
Pencil, \$1.00

NOTE: The Junior Pen comes only with Fine, Medium, Coarse or Stub points.



No. 3V-C Claret Pen, \$3.00
No. 93V-C Claret Pencil, \$1.25

Pens also in 3V-J Jet, 3V-G Green P., 3V-B Black P., 3V-S Steel Q.,

and Pencils in 93V-J Jet, 93V-G Green P., 93V-B Black P., 93V-S Steel Q.

Pens, \$3.00
Pencils, \$1.25



No. 3-B Black Pearl Pen, \$3.00
No. 93-B Black Pencil, \$1.25

Also made in No. 3-S Steel Quartz Pen, \$3.00
No. 93-S Steel Quartz Pencil, \$1.25
No. 3-G Green Pearl Pen, \$3.00
No. 93-G Green Pearl Pencil, \$1.25



No. 3-J Jet Pen, \$3.00
No. 93-J Jet Pencil, \$1.25

All of the above pens—except Waterman's Junior—may be had with any of the points described on the reverse of this spread — but for the Purple, Yellow or Green point there will be an extra charge of 50 cents.

No. 580365, Price \$60.00
Golfer, 8 inches high—
Gold Finished—Oval—
8x13—Black Marble—
Tray—Name Plate—
Two No. 0365 Gold
Finished Pens, One Red
End, One Black End.



Waterman's Desk Sets Make Appreciated Trophies!

WATERMAN'S GYRO-SHEATH DESK SETS are especially appropriate for trophies or prizes for golf clubs, bowling clubs, bridge clubs, whippet and greyhound clubs or for any sport or contest where a trophy that combines ornamental beauty and genuine usefulness is desired.

In this folder are shown a few of the many beautiful Waterman's Desk Set designs which may be had for nearly every competitive sport — and at a wide range of prices. Each set is a work of art, designed and built by skilled craftsmen from the very finest materials and will serve as a beautiful and highly useful souvenir to the recipient.

L. E. Waterman Co., 609 Market St., San Francisco

191 Broadway
NEW YORK

40 School Street
BOSTON

129 So. State Street
CHICAGO

Waterman's Desk Sets

for Modern Offices and Homes
and for Trophies and Prizes.



No. 509/67—4x6 White Onyx, Belgian Black or African Brown base, chrome sheath, name plate and corner stands, Jet pen—\$20.00. Green Onyx base, gold-filled sheath, name plate and corner stands, pen to match—\$23.00.

No. 516/62½—3" Black and Gold Marble base, chrome sheath, Jet pen—or Onyx base, gold-filled sheath, Brown pen—\$5.00.

No. 501/62—2¼x4 Black Aragonite base, chrome sheath, Jet pen—or Green Onyx base, gold-filled sheath, Green Pen—\$8.00.

No. 501/62½—Black and Gold or Belgian Black Marble, or White or African Brown Onyx base, pens and trim to match—\$6.00.

No. 506/62—3x4 Sapphire Blue or Steel Grey glass mirror base, chrome sheath, Jet pen—or Gold glass mirror base, gold-filled sheath, Jet pen—\$9.00.

No. 70/62—Green Onyx base, 3x3 gold-filled frame and sheath, Jade Green pen—\$10.00.

No. 390/62—Dachshund, on 4x6 White Onyx base, chrome name plate, Jet pen and sheath—\$18.00.

No. 384/62—Jet Turn-Over Perpetual Calendar, on 4x6 White Onyx base, Jet pen and sheath—\$17.50.

No. 505/67—4x6 Black and Gold Marble, White Onyx or African Brown Onyx base, gold-filled pen sheath and name plate and pen to match—or Belgian Black Marble base, chrome finish—\$15.00. With Brazilian Green Onyx base, gold-filled trim—\$18.00.

No. 446/67—Waltham 8-Day Clock, 7½x12 Black and Gold Marble base, sheaths and name plate English gold finished, two pens, Letter Rack, Opener, Rocker Blotter—\$100.00.

No. 508/67—5¼x8¼ Belgian Black Marble base ornamented with a deep inlay of Red and White, chrome trimmed Jet sheath and chrome name plate, Jet pen—\$18.00.

No. 436/67—Gold-filled cylinder type Perpetual Calendar, name plate and sheaths, 7x13 Brazilian Green Onyx base, two pens to match, as illustrated—\$55.00. With a White Onyx, Black and Gold Marble or Belgian Black Marble base—\$50.00.

No. 447/62—A new and most unusual design in a desk set, 5 inches diameter, Black Marble and White Onyx base, Jet pen and sheath—\$15.00.

No. 419/67—Elephant, 8 in. high, Green Colored Solid Bronze, 7x13 Green Onyx base, sheath and name plate Matt Green Gold finished, pen to match—\$75.00.

We also have various other styles of desk sets especially appropriate for trophies or prizes.

Waterman's Desk Sets are as

WATERMAN'S GYRO most beautiful desk sets they are as practical as they are beautiful—just where you want it—ready for instant use. The gyro pens can be moved to any position—straight up—right—or frontward—the stand is strong enough to hold the Gyro-Sets. On each and every stand is a place suitable for engraving a name, etc. Each set is furnished with two pens, perfectly balanced for each pen equipped with a nib of the recipient's style of writing.

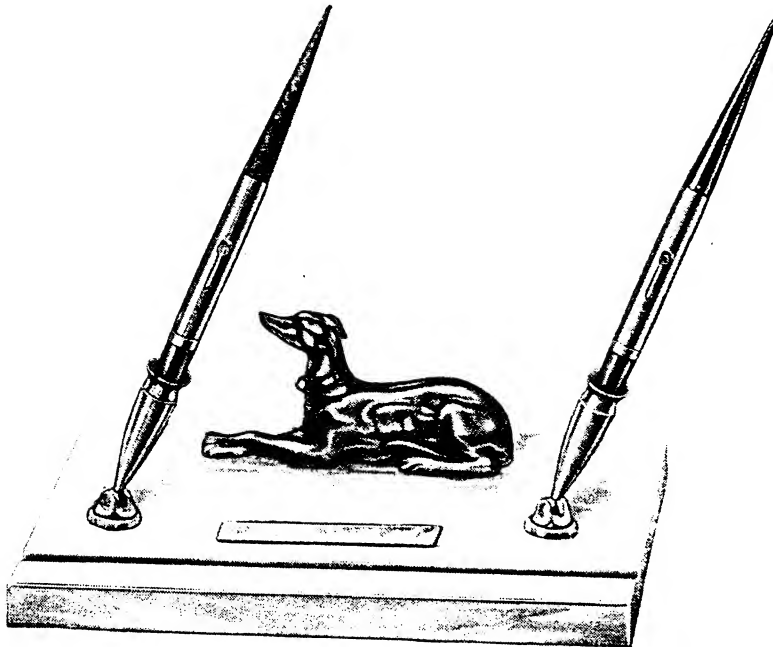

No. 510365, Price \$50.00

Greyhound, lying—Bronze Finished—6 x 10—Onyx—Name Plate—Pencil Groove—Two No. 0365 Bronze Finished Pens, One Red End, One Black End.



No. 530365, Price \$60.00

Horse—Bronze Finished—Oval—6 x 12—Black Marble—Name Plate—Two No. 0365 Bronze Finished Pens, One Red End, One Black End.

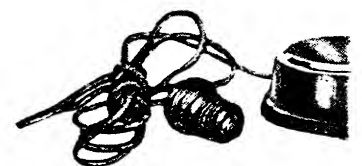

No. 830

Lamp—Bronze Finished—Two Pen Holders

Practical as they are Ornamental!

WATH DESK SETS are the
 on the market today—and
 ornamental. Pen is always
 the nib moist and ready
 Gyro-Sheath can be freely
 at up—inclined to left or
 arings being just tight
 th wherever it is placed.
 be noted a name plate or
 name of recipient, date,
 ith one or two smooth-
 aterman's desk set pens,
 b that will exactly suit

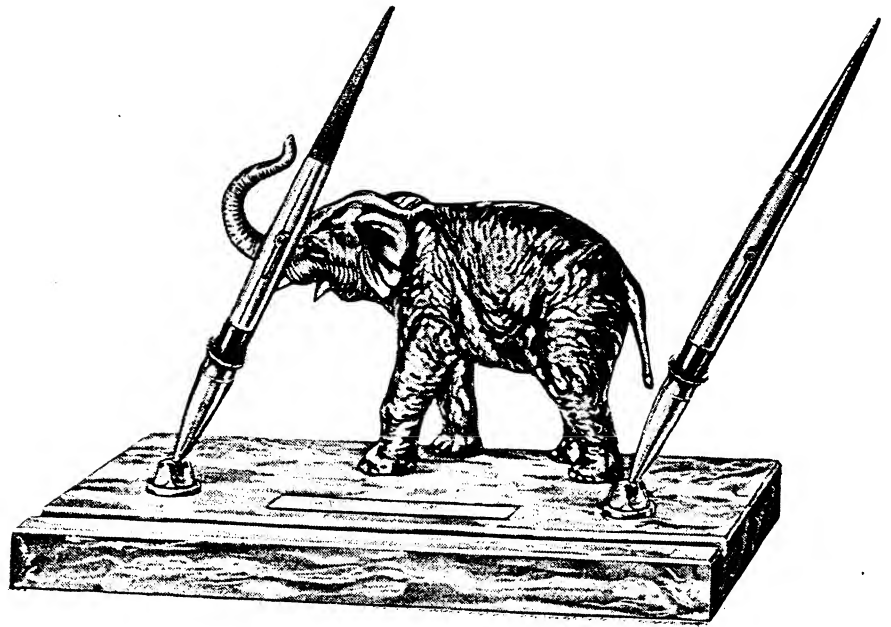

No. 500365, Price \$55.00

Elephant — Bronze Finished — 8 x 13 — Onyx — Pencil Groove
 —Name Plate—Two No. 0365 Bronze Finished Pens, One Red
 End, One Black End.



Price \$33.00

ment Shade—One No. 67 Pen,
 Various Colors.

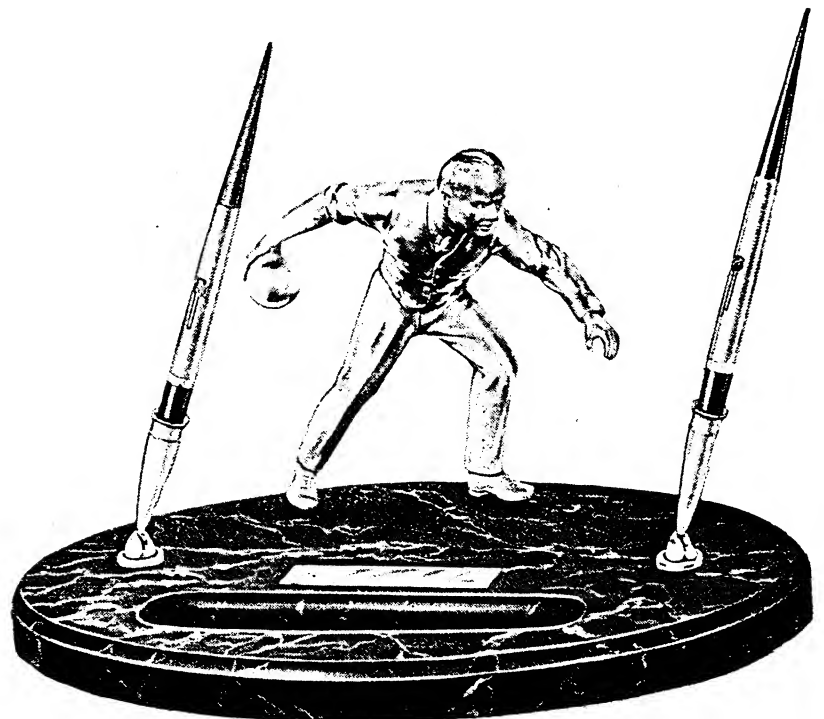

No. 460365, Price \$60.00

Bowler, 6 inches high—Gold Finished—Oval—8 x 13—Black Marble
 —Tray — Name Plate — Two No. 0365 Gold Finished Pens, One
 Red End, One Black End.

A Suitable Trophy for Every Sport

No. 430365

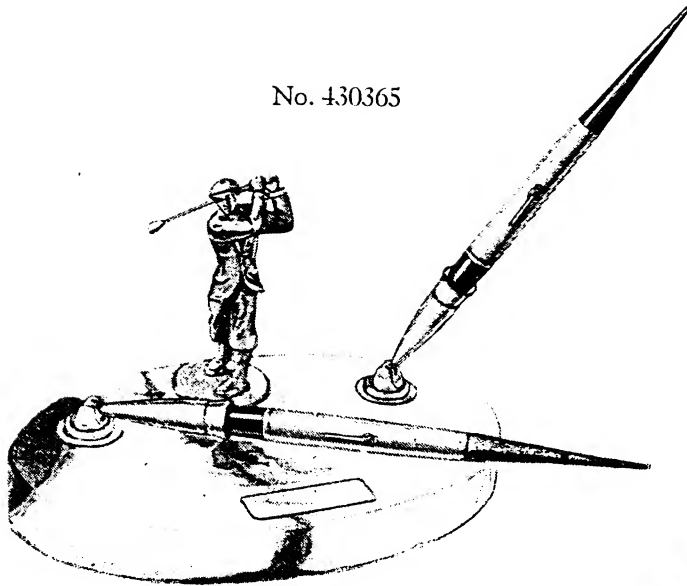

No. 430365, Price \$50.00

Golfer, 5 inches high—Gold Finished—Oval—5 x 8—Onyx—Tray—Two No. 0365 Gold Finished Pens, One Red End, One Black End.

No. 540365



No. 540365, Price \$35.00

Police Dog, sitting—Bronze Finished—7 x 10—Onyx and Black Marble—Oval—Name Plate—Pencil Groove—One No. 0365 Bronze Finished Pen, One Black End.

No. 410365

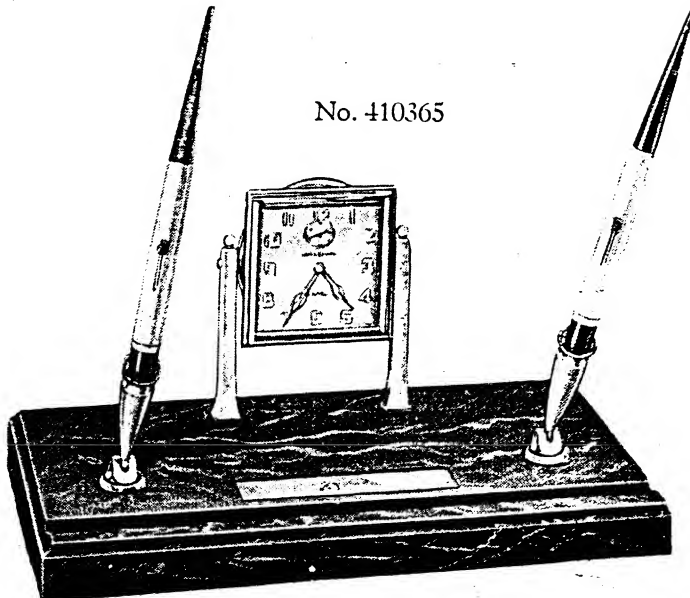

No. 410365, Price \$110.00

Waltham Clock—Gold Finished—Name Plate—Pencil Groove—6 x 10—Onyx or Black Marble—Two No. 0365 Gold Finished Pens, One Red End, One Black End.